

SNYDER INDUSTRIES INC.

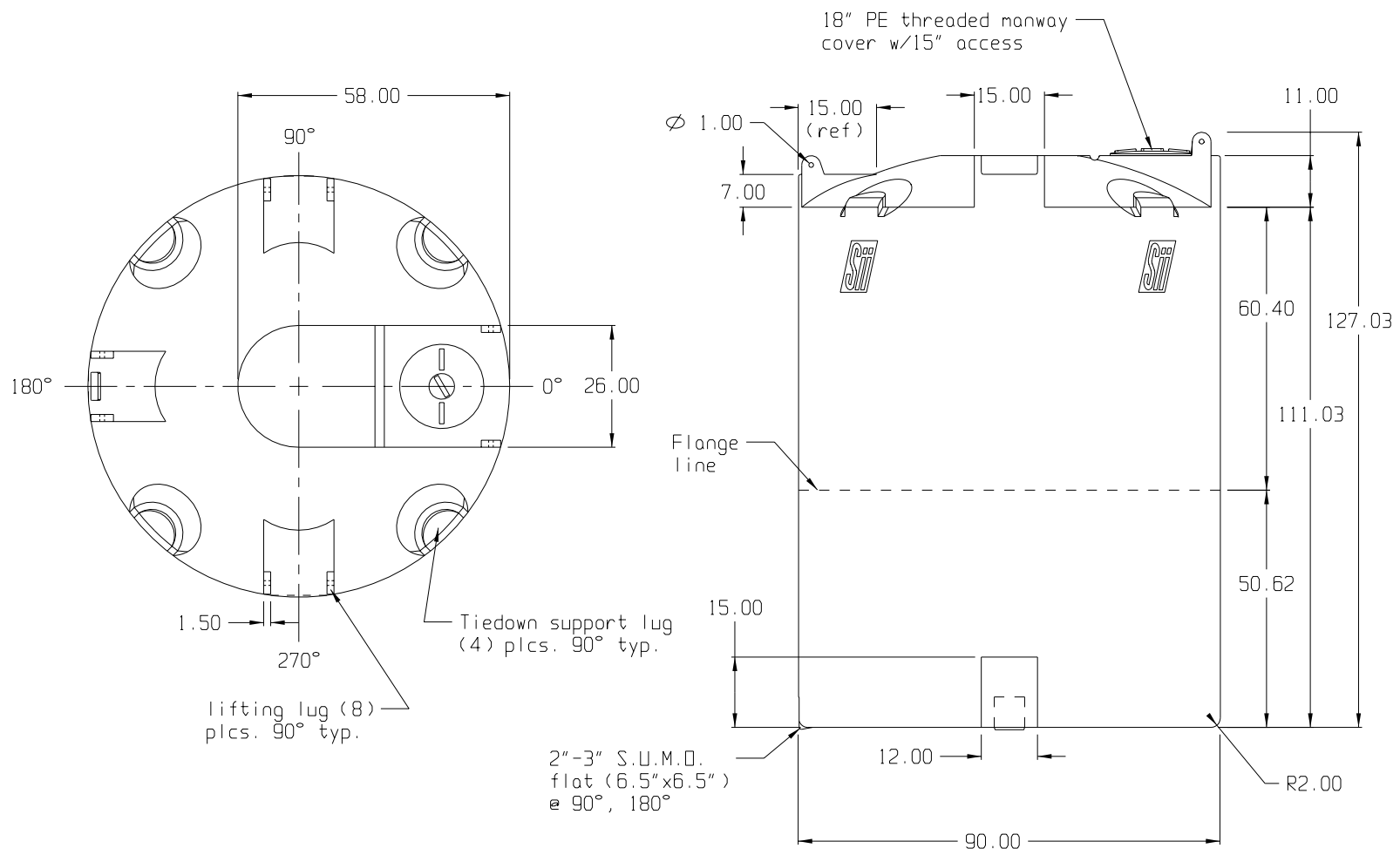

(all dimensions in inches)

BASE FITTINGS TO BE LEFT INSTALLED AT TIME OF SHIPMENT PER Sii PROCEDURE

PART # TANK: 5130--L

3,000 GALLON FLAT BOTTOM TANK

REF#: 0000

06/24/02