

TOP VIEW

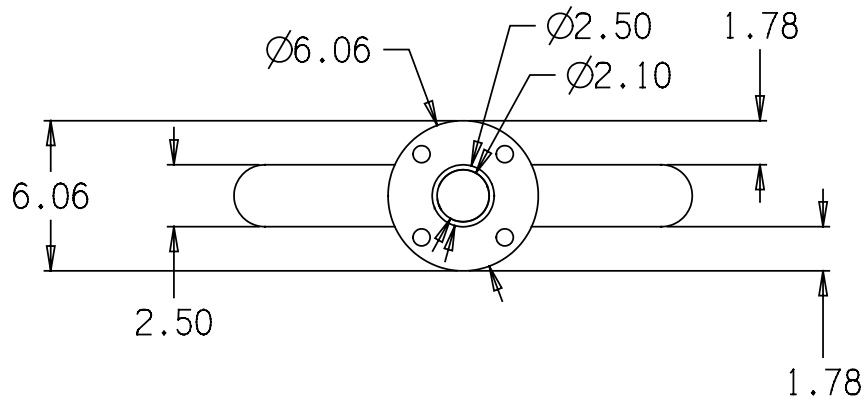

LEFT SIDE VIEW

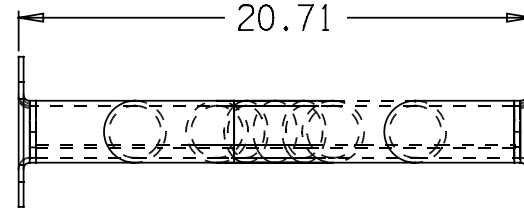

FRONT VIEW

(all dimensions in inches)

PART # 5390100N--L

REF#: 0000

10/06/03

BASE FITTINGS TO BE LEFT INSTALLED AT TIME OF SHIPMENT PER SII PROCEDURE

2" FLEXMASTER FLEXIBLE FITTING CONNECTOR